

FENDT

Fendt 900 Vario





Fendt 900 Vario – Ready for more.

Fendt is already thinking ahead, and has the answer to the challenges of the future: The new Fendt 900 Vario. Discover why you're ready for more with the Fendt 900 Vario.



Without compromise.

Ready for more? It's got to be the new Fendt 900 Vario – impressive on every level – efficiency, grip, versatility, safety, comfort and intelligence.

Engine	930 Vario	933 Vario	936 Vario	939 Vario	942 Vario	
Rated power ECE R 120	kW/hp	217/296	239/326	261/355	283/385	305/415

Large tractor for every job

The Fendt 900 Vario is awesome at everything. With groundbreaking solutions so you're ready for those everyday challenges. Now, and in the future.

- Power segment 296 to 415 hp
- 9.0-l MAN engine:
- VarioDrive drive train
- Smart AWD VarioDrive
- Fendt iD low engine speed concept
- 2-circuit hydraulics
- VarioGrip tyre pressure regulation system built-in
- Max. tyre diameter 44" (2.20 m)
- Front PTO
- Fully road legal at 60 km/h*
- Reverse drive control

* depends on country-specific legal regulations



- Fendt Connect telemetry system
- Realtime display with Smart Connect
- New safety locking system
- Bonnet camera
- Fendt Life Cab for comfort
- Infotainment package
- Premium sound system
- Electric retractable mirror (adjustable on the terminal)
- Pull-out tool box with 3 different equipment options

Ready for anything.

Details that make all the difference.



Engine

- 9.0 l capacity
- Power range: 296 - 415 hp
- Common-rail system with up to 2,500 bar injection pressure
- More efficient fuel combustion thanks to high compression
- Higher internal-engine efficiency with eliminated exhaust gas recirculation and separating hot and cold sides
- Turbo-supercharger with variable turbine geometry (VTG)
- Low noise emissions
- Engine oil changes: 1,000 operating hours



Reversible fan

- Clean the radiator grille separately by completely reversing the air flow direction
- Maximum fuel efficiency with cooling capacity adjusted to the needs of each part
- Interval-led reversible fan option – can be timed in the Varioterminal
- Maximum ease-of-use when using it with Variotronic¹¹



Front axle

- Levelling single-wheel suspension: compared to non-sprung front axle up to 6% more tractive power on the field
- Automatic suspension lock from 20 km/h
- Up to 8.5 t front axle load at 60 km/h
- Avoids 'power hopping' for optimal grip
- Maintenance-free bearings and joints



Fendt iD low engine speed concept

- All vehicle components are perfectly aligned to the right speeds, including the engine, gearbox, fans, hydraulics and all auxiliary units
- Reach the highest torque at low revs
- Low fuel consumption, all the time
- Extended service life



VarioDrive drive train

- Separate drive for front and rear axles
- No need to manual switch to all-wheel drive
- Optimum engine/transmission tuning together with Fendt iD low speed design
- Always the smallest possible turning circle with 'pull-in-turn'
- Gear oil change only required every 2,000 operating hours
- No special oil required

INCREASED EFFICIENCY

Power and efficiency together.

Dynamic. Durable. Fuel-efficient.

The new Fendt 900 Vario uses pioneering technologies that make your day-to-day work more economical. At full engine power.

9.0-l MAN engine:

The 6-cylinder in-line engine delivers 296 to 415 horsepower. Stands out from the rest, with a power density that belies its compact and lightweight design. A Common Rail system with an injection pressure of up to 2,500 bar and a turbo-supercharger with variable turbine-geometry (VTG), deliver the power evenly and dynamically even at low engine speeds. All engine parts are set for a maintenance interval of 1,000 operating hours.

Fendt iD low engine speed concept

Every vehicle component, like the engine, gearbox, fans, hydraulics and all the secondary users are designed to perfectly suit low engine speeds. The constant torque of the Fendt 900 Vario ranges from 1,150 rpm to 1,350 rpm. It means Fendt iD can continually lower fuel consumption for a longer service life.

VarioDrive

Fendt VarioDrive delivers stepless, dynamic driving at any speed from 0.02 km/h to 60 km/h. Front and rear axles are driven separately. With the help of an intelligently controlled all-wheel clutch, torque is distributed as required between the axles. The power is automatically shifted to the gripping axle.

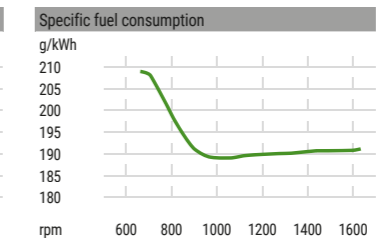
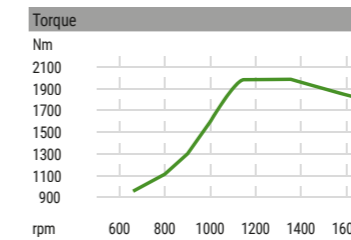
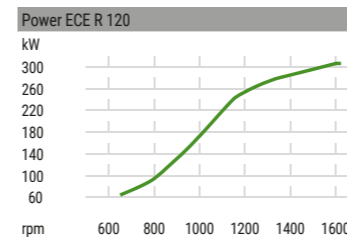

MORE GRIP

All the traction you need.

Full power

The challenge with large tractors is to transfer enormous tractive force to the ground. Full traction with maximum soil protection is a top priority. The Fendt 900 Vario is ready for more grip. We have a number of options to make your tractor perfect for your needs.

Fendt VarioGrip with Fendt Grip Assistant

With the integrated tyre pressure regulation system Fendt VarioGrip, the tyre pressure can be adjusted with just one click in the Varioterminal. The Fendt Grip Assistant supports you with specific ballast, giving the both right tyre pressure and the ideal work speed. Then you have Fendt Grip Assistant to calculate the best ballast depending on the attachment.

Ballast and wheel weights

Choose between four different ballast weights (870 kg to 2,500 kg) for front and rear work, as well as four different wheel weights (300 kg to 1,250 kg) on each side.

Ready for any job

With the Fendt 900 Vario you can choose between a flange axle and a bar axle (2.5m or 3.0m), depending on your requirements. With the bar axle you can adjust the track setting. Increase the traction power with larger tyres. The 750/70 R44 tyre, specially developed for the 900 Vario, has an impressive diameter of 2.20 m.



MORE VERSATILE

Ready – for anything.

Equipped for all kinds of work

An extended application range means higher usage rates, which in turn have a direct impact on the cost-effectiveness of your machine. Whether field, road or forestry work. To make your Fendt 900 Vario ideal for the job at hand, you can customise the tractor to suit your needs.

Flexible hydraulic system

The modular design of the hydraulics opens up a whole range of options. This includes a choice of 3 oil flow rates: 165 l/min, 220 l/min or 2 hydraulic pumps (220 + 210 l/min) with a volume flow of up to 430 l/min. The 2-circuit hydraulics system allows two driven units to be supplied with different amounts of pressure and oil flow. The valves come in a choice of UDK, DUDK and FFC couplings. The coupler housing accommodates different coupling sizes. As you would expect, all the coupling connections are easy to handle. The DUDK and FFC couplings can be coupled under pressure from both sides. Change around for different applications. The Fendt 900 Vario provides connections for up to eight control units; six at the rear and two at the front.

Individuality at the front and rear

You can choose to customise the equipment on your Fendt 900 Vario. Both at the front and rear. In addition to the comfort ballast pickup, there are two front power lift versions available. With the retractable rear power lift, you can configure the vehicle just for traction work. You decide which connections and functions you need. With a fully equipped rear, the Fendt 900 Vario features a rear power lift, PTO, hydraulic side struts, attachment coupling, drawbar, ISOBUS, Power-Beyond, and much more. Not forgetting the full range of modular attachment systems like the CUNA coupling, Piton-Fix or Hitch (country-specific). At the front, you can opt for a front power lift, PTO, up to two front valves and an ISOBUS plug.

Reverse drive control

Put your Fendt 900 Vario to even further use with the optional reverse drive control. The pneumatic turning system lets you quickly rotate the entire operator platform. In reverse drive control mode, you still have your familiar control environment with the best view over the rear implement.

Tillage work requires tractive power and versatile hydraulics. With up to six control valves at the rear, you're ready for any challenge.



Call for traction, PTO and hydraulics power at the same time, any time. With ever-optimum fuel requirements. If you're always switching between the field and road, VarioGrip ensures the best efficiency.



Fully rotate the operator platform to work in complete comfort and have best view of the implement. The hydraulic side struts make light work of fixing the attachment. The bar axle offers a high degree of flexibility with different tyres and tracks.



SAFER AND EASIER TO USE

Ready to feel good.



Security lock system

Ultimate protection against theft and unauthorised fuel siphoning: The key system has various locking barrels, which are randomly assigned to one vehicle only. Only this key then unlocks the tractor bonnet, cab door, ignition lock and fuel tank.

More secure

Everyday security is non-negotiable. Features like the new security locking system, which fully protects the vehicle and its contents from theft, the bonnet camera and the electrically telescopic mirrors, ensure greater security in everyday life.

Everything in sight

The optional electrically adjustable mirrors and wide-angle mirrors give you the widest possible panoramic view. The mirrors can be extended to adapt to any vehicle width. You can do all this from the comfort of your cab on the Varioterminal.

You're in safe hands with Fendt Assist systems

Assist systems like Fendt Stability Control (FSC), handbrake assist and steering lock ensure safety on the road and on the field. Fendt Stability Control stabilises the vehicle on road journeys, from speeds of 20 km/h. The electro-pneumatic handbrake controls the brake on its own when you get out of the cab or turn the engine off. Likewise, the handbrake assist automatically releases the handbrake when you start off. The steering lock reduces the risk of the trailer rocking with unlocked axles at high driving speeds.

Pure comfort – Fendt Life Cab

The Fendt 900 Vario's spacious Life Cab offers the highest level of comfort. From the pneumatic 3-point suspension, the air-conditioned seat and numerous storage compartments, to the new infotainment package with 4.1 sound system, the cab with all its features provides an exceptional feel-good factor.

Infotainment package with sound experience

Four high-end speakers and a subwoofer deliver superior sound quality in the cab. Enjoy playback from your smartphone via USB, AUX-IN and Bluetooth. FM/AM/DAB+/HD and two antennas with permanent channel search also ensure excellent radio reception. Make phone calls in your Fendt 900 Vario with a fantastic quality hands-free kit: 8 microphones installed in the sunroof mean your hands are free and sound is excellent. Controls are on the Varioterminal and the side membrane keypad.

Bonnet camera

The built-in front camera gives the driver a direct view of the front power lift. The image is shown on the Varioterminal. This makes it much easier to attach and detach front weights and attachments. You can spot anyone right in front of the tractor and avoid any accidents.



Fendt Stability Control

More safety and improved driving comfort on corners: Fendt Stability Control automatically reduces the side tilt at driving speeds above 20 km/h and actively stops any tipping on corners. So that the machine can still swing about in the field, the system kicks in only when braking at speeds up to 15 km/h.



Electrically adjustable comfort mirrors

The rear and wide angle mirrors can be easily adjusted electrically on the terminal. The mirror brackets also go in and out easily. Blind spots are a thing of the past. Even when using large attachments in tight spaces, the driver has the best overview at all times.

MORE INTELLIGENCE.

Ready for the future. With smart solutions from Fendt.



Fendt Connect telemetry system

Our basic telemetry package is the best way to analyse and manage your fleet. Fendt Connect can read, store and analyse machine data as part of the package.

This makes it easier to plan usage times and machine capacity, which ultimately helps you increase the cost-effectiveness of your vehicles. View machine data on your PC or smart device, including:

- Machine position and route (map view)
- Fuel consumption
- Speed
- Operating time
- Machine capacity
- Error messages
- Upcoming service intervals
- And more.

Realtime display with Smart Connect

The optional Smart Connect app visualises machine parameters in real time without storing any data. As a trusted brand of agricultural solutions, data security is extremely important for Fendt. Using digital Fendt devices is subject to strict European IT security standards.

Always on track – Fendt VarioGuide Contour Assistant

With VarioGuide – the central track guidance system for Fendt machines – you always work with the utmost precision. Choose from two receiver options (NovAtel® or Trimble®) and a variety of correction data signals. The Fendt VarioGuide Contour Assistant helps you work even more efficiently and easily with the new VarioGuide wayline types, Contour Segments and Single Track. With Contour Segments, you can use different waylines at the same time. The tractor automatically switches to the right wayline based on its current direction and position. The guidance system is a big help on the headland.

Needs-based management with SectionControl and VariableRateControl

Easily control both the fully automated SectionControl and the section-specific application of products with VariableRateControl on the Varioterminale.

Up to date. Even in the future. Fendt software updates

With our software updates, your Fendt 900 Vario will always be up-to-the-minute, even in years to come. Just have your dealership install the latest updates free of charge up to twice a year during a regular service (labour is charged).



FENDT VARIODRIVE

Drives your success – at full power.

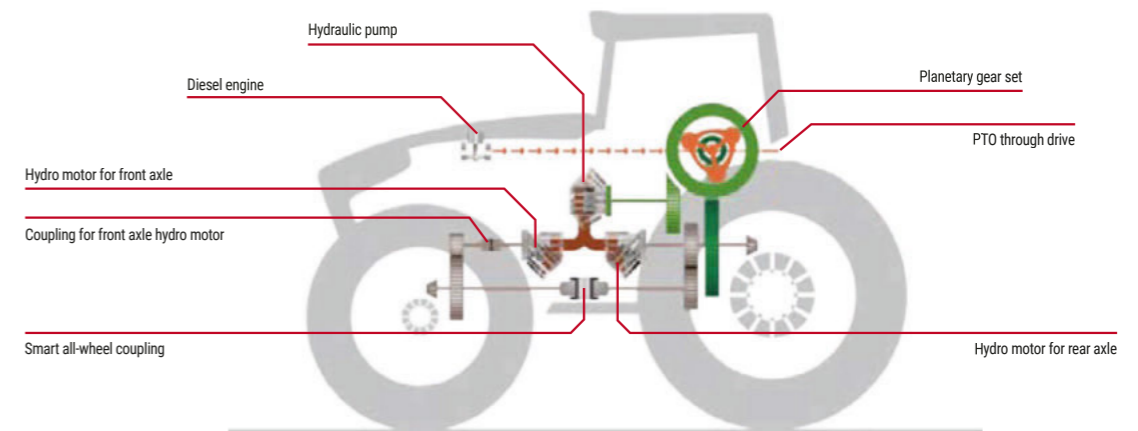

Diagram showing the Fendt VarioDrive design.



Fendt Grip Assistant

The Grip Assistant recommends the right tyre pressure and ballasting for a defined speed when in Speed Select mode. In Ballast Select mode, the assistant recommends the ideal working speed as well as the optimal tyre pressure for a defined ballast.

Fendt VarioDrive

The revolutionary thing about this gearbox is a variable all-wheel drive, applied with independently driven axles. The drive train works on a hydrostatic-mechanical distribution of power. The diesel engine drives the planetary set. The ring gear, in turn, drives the hydropump. The hydropump then supplies two hydromotors. One hydromotor for the front axle and one for the rear axle. The rear axle is also driven mechanically. Fendt VarioDrive provides permanent traction.

Power distribution through Fendt Torque Distribution

The tractive power is decisive. You can only get the power to where it is needed by having permanent torque distribution between the front and rear axles. This is where Fendt Torque Distribution comes into play. The torque is distributed in a fraction of a second. If the front axle starts to slip, the smart-controlled all-wheel coupling automatically closes. The highlight of the variable all-wheel drive lies in the interaction of the rear axle and the front axle. A smart all-wheel clutch shifts the torque between the axles when needed. The torque is shifted to the gripping axle. If the rear wheels are not gripping, the torque is shifted to the front axle, and vice versa.

Tightest turning circle thanks to pull-in-turn

At the headland, Fendt VarioDrive makes all the difference. The front wheel drive can actively pull the tractor into the turn. This is the 'pull-in-turn' effect. This reduces the turning circle by up to 10%. When you turn a corner, the front wheels have to travel further than the rear wheels. As the oil of the hydropump can spread between both hydromotors, the speed on the front wheels automatically increases.

VarioGrip

The requirements are as individual as the customer. Because there are almost no limits to customer requests, Fendt offers an extensive range of tyre options. There's just one answer to 'maximum soil protection, with maximum power transmission' – it's Fendt VarioGrip. With Fendt VarioGrip, you can easily control the inner tyre pressure from your cab while on the move. Less tyre pressure increases the contact area of the tyre. And with a bigger contact area, there is more tread on the ground and the weight of the vehicle is spread over a larger area. On the road, on the other hand, you need more inner tyre pressure. This reduces rolling resistance and minimises wear and tear on the tyres. Compared to working on the field with unadjusted tyre pressure, with VarioGrip you can achieve up to 10% more tractive power and cover up to 8% more area with up to 8% lower fuel consumption.*

* Test results from South Westphalia University of Applied Sciences, Faculty of Agriculture, Soest.

Fendt Grip Assistant

Besides the tyre pressure, the ballasting and working speed are also decisive for power transfer to the ground. The new solution is called: Fendt Grip Assistant. With the assistant, which is fully integrated in the Varioterminal, the right tyre pressure and optimal ballast weight or driving speed can be determined quickly. Depending on the implement or ballast of the tractor, the Grip Assistant recommends either front and wheel weights, or the optimal working speed.

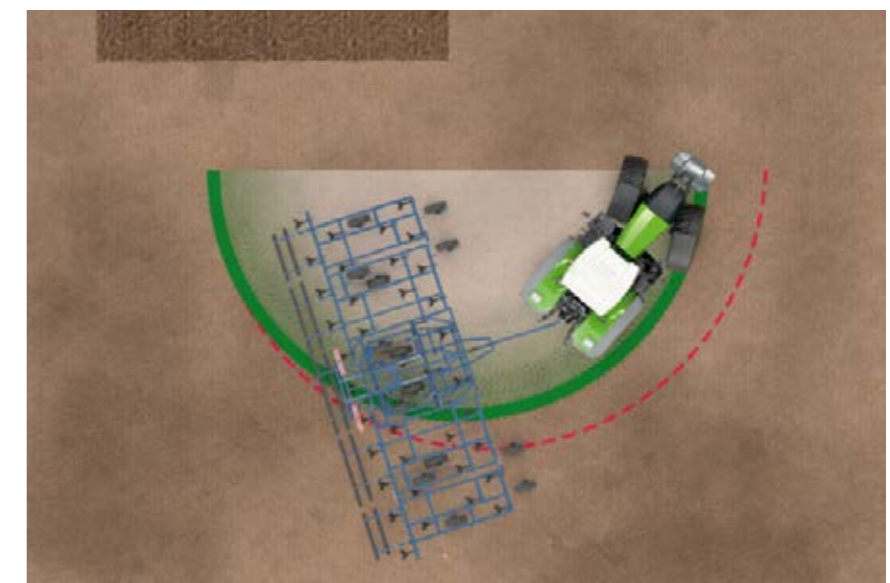

Small turning radius thanks to the 'pull-in-turn' effect, e.g. 6.1 m for the Fendt 930 Vario with standard tyres.

Makes your work easier.

With Fendt VarioGuide, you have a choice of two receivers, NovAtel® or Trimble®:

NovAtel® receiver



NovAtel® Standard
Correction signal: SBAS (EGNOS & WAAS)
± 15-30 cm track to track accuracy; ± 150 cm repeatable accuracy

NovAtel® – extendible correction signals
Correction signal: TerraStar-L
± 15 cm track to track accuracy; ± 50 cm repeatable accuracy
Correction signal: TerraStar-C
± 4 cm track to track accuracy; ± 4 cm repeatable accuracy

NovAtel® RTK
Correction signal: RTK
± 2 cm track to track accuracy; ± 2 cm repeatable accuracy

Mobile network / radio

Trimble® receiver



Trimble® Standard
Correction signal: SBAS (Egnos & Waas)
± 15-30 cm track to track accuracy; ± 150 cm repeatable accuracy

Trimble® – extendible correction signals
Correction signal: RangePoint® RTX
± 15 cm track to track accuracy; ± 50 cm repeatable accuracy
Correction signal: CenterPoint® RTX and CenterPoint® RTX Fast
± 4 cm track to track accuracy; ± 4 cm repeatable accuracy

Trimble® RTK
Correction signal: RTK
± 2 cm track to track accuracy; ± 2 cm repeatable accuracy

Mobile network / radio

Because the receivers are installed under the roof hatch, they are fully protected against theft, weather and damage.

- NovAtel®:**
- high-performance standard receiver
 - Optional use of RTK ASSITM: Bridging during RTK dropouts of up to 20 minutes

- Trimble®:**
- extremely efficient receiver with even more options
 - Up to 20 minutes' bridging if the RTK connection drops (Trimble®-xFillTM technology)
 - Optional use of xFillTM Premium (unlimited bridging)

The Power joystick has two buttons for the Variotronic™ headland management system, cruise control and engine speed memory. The Varioterminal 7" gives an excellent overview.



The Profi joystick has four buttons for the Variotronic™ headland management system, two cruise controls, two engine speed memories and buttons to control two hydraulic valves. The Varioterminal 10.4" has two camera inputs.



VarioGuide Contour Assistant

The VarioGuide Contour Assistant software option adds Contour Segments and Single Track to the familiar VarioGuide wayline types. This makes your field work even easier and more efficient.

Contour Segments wayline

Until now, drivers have had to record different waylines so they can work on the different sections of field. They also had to manually switch between the waylines as they worked. You can use the Contour Segments wayline to record each segment and wayline in a one-off circumnavigation of the field, or apply them directly from the existing field boundary. All relevant waylines are grouped into one unit. Contour Assistant automatically detects the right track.

Single Track wayline

Use Single Track to record an almost endless track with an open contour. You no longer need to automatically generate parallel tracks. This feature is ideal for plant protection, as you can record a single track and apply it to the whole field.

Variotronic™ headland management

With the Variotronic™ headland management system, you can apply any of your turning sequences at the touch of a button. You can store up to 25 implements. In combination with VarioGuide, Variotronic™ automatically detects the position and automatically initiates all the recorded steps at the headland.

Documentation with Fendt VarioDoc

Field data is stored in the field database with the VarioDoc documentation system. VarioDoc Pro also records GPS position data and transfers the data in near realtime.

2 installation levels available	VarioDoc	VarioDoc Pro
USB data transfer	✓	✓
Bluetooth data transfer	✓	✓
Mobile network data transfer New and completed jobs		✓
Semi-automatic documentation Under trigger conditions (rear power lift, PTO...)	✓	✓
GPS location data (every 5m) Example: Speed, engine speed, consumption...		✓

Power lift and hydraulics.

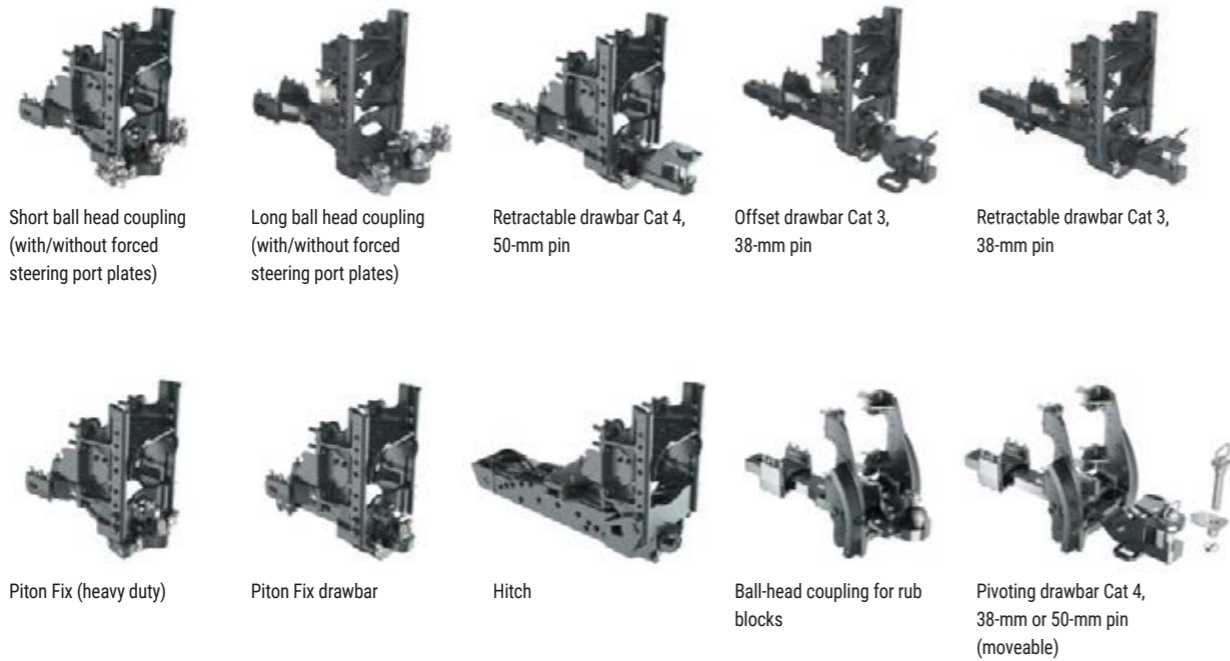

Short ball head coupling (with/without forced steering port plates)

Long ball head coupling (with/without forced steering port plates)

Retractable drawbar Cat 4, 50-mm pin

Offset drawbar Cat 3, 38-mm pin

Retractable drawbar Cat 3, 38-mm pin

Piton Fix (heavy duty)

Piton Fix drawbar

Hitch

Ball-head coupling for rub blocks

Pivoting drawbar Cat 4, 38-mm or 50-mm pin (moveable)



Rear attachment:



Quickhitch

Rub block with ball ends

Rub blocks with open arrester



Rear power lift with quick arresters and side support

No rear power lift

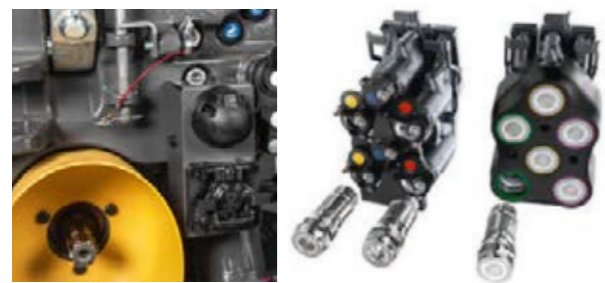

At the front, the Fendt 900 Vario offers the option of an integrated power lift with position and load relief control. You can also have up to two front valves with a flow volume of up to 100 l/min, a front PTO and an ISOBUS plug.

Lighting.

The front-facing work area is fully illuminated with 4 powerful LED headlights. The LED daytime light provides better visibility on the road.

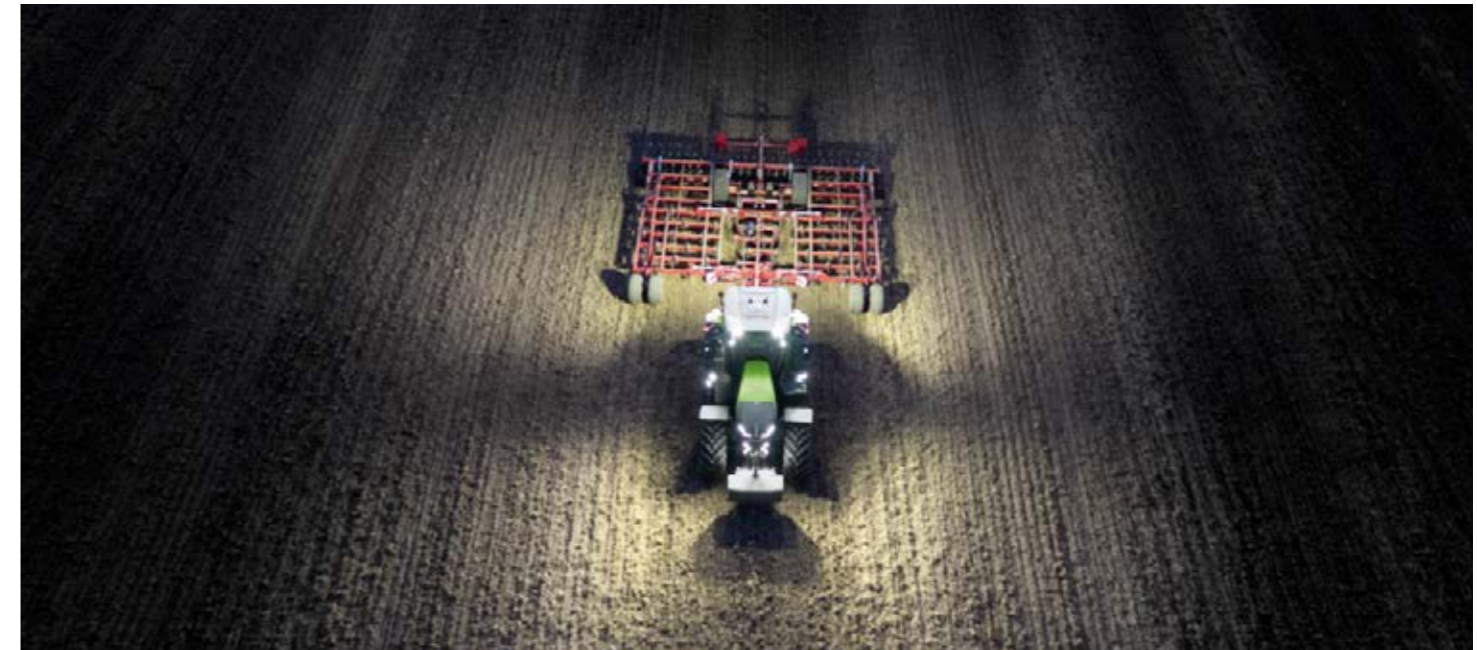

A total of 66,230 lumens of LED light provide all-round illumination and more visibility at night.



With the coming-home function, you don't have to stumble around in the dark when you turn the engine off. Headlights and step lights safely guide you home.



Get in and out of the cab safely even in the dark, with the entrance lighting built into the side of the tank.



The ambient lighting creates a pleasant atmosphere for night work. All functional elements have backlighting.

Full functionality.



With the auxiliary device mounted on the right side of the cab, you can easily arrange additional terminals for the best visibility.



The convenient mobile phone holder on the armrest can also be adjusted for different smartphone models.



All the controls are arranged in a simple and clear layout on the backlit membrane keypad.



Functional storage: choose from 3 options: 1) Pull-out washing bowl



2) Plastic pull-out toolbox



3) Metal pull-out toolbox



For use with reverse drive control, just rotate the operator platform a full 180°. You can then use all your controls in reverse as easily as you do in forwards mode. Despite the reversing driver station, passengers do not have to do without the comfort seat.

You can electrically adjust the rear and wide angle mirrors. The mirror brackets also go in and out. This gives you an uninterrupted and outstanding overview, even with large attachments. You can make the settings on the terminal with buttons or by touch (hotkeys in the cockpit).



Sunscreen blinds both at the front and side protect the driver from sun glare.



The 220° windscreen wiper on the right cab window ensures the best view to the right, even under the toughest conditions.

Tyres and ballast.

Versatile tyre options: Choices include our latest large tyre option with a max. diameter of 2.20 m, twin tyres up to 750/70 R44 and a Row Crop version with 60" track*.

*country-specific



Single EU



Row Crop



Single NA



Dual EU



870 kg



1,250 kg



2 x 300 kg



2 x 600 kg

High flexible ballast: The Fendt 900 Vario comes with various front weights from 870 kg to a maximum of 2,500 kg. Wheel weights include 2 x 300 kg to 2 x 1,000 kg (2 x 1,250 kg with Row Crop).



1,800 kg



2,500 kg



2 x 650 kg



2 x 1,000 kg



2 x 1,250 kg (with Row Crop)



FENDT SERVICES

The best product with the best care and service.

With Fendt, you get a cutting edge product that will overcome the toughest of challenges. That's why you can expect that little bit extra when it comes to services from highly-efficient, certified Fendt dealers:

- Fast lines of communication between you and our trained service team.
- 24/7 availability of replacement parts throughout the season
- 12-month warranty on Fendt original parts and their fitting

100% quality. 100% service: Fendt Services
We offer outstanding services to offer you the best possible reliability of use and efficiency from your Fendt Machine:

- Fendt Demo service
- Fendt Expert operator training
- AGCO Finance – finance and lease deals
- Fendt Care – servicing and guarantee extensions
- Fendt Certified - Pre-owned machine programme



+44 330 123 9909

Your Fendt dealers are always there when you need them, and have just one aim – to make sure your Fendt machines are ready for action at any time. If something does go wrong during harvest time, simply call your certified service centre 24/7 on the emergency hotline.

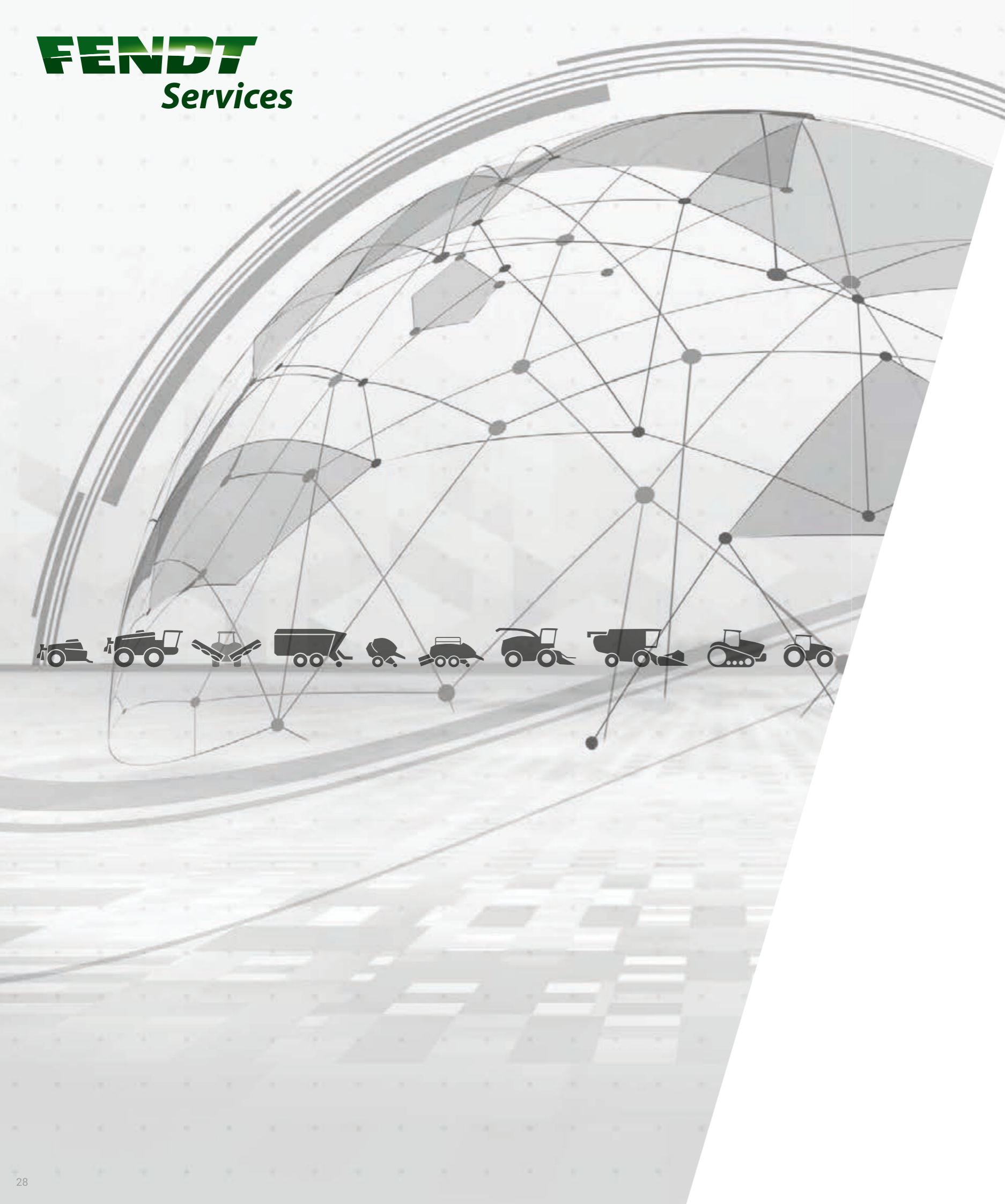

FENDT SERVICES

Rest assured that your machine will be ready for action tomorrow.

Fendt Demo service

Is this a new purchase? You'll love our Fendt solutions and overall efficiency. Let the Fendt Demo service make the decision easier.

Fendt Expert operator training

We help you get the most out of your vehicle. With the help of our exclusive Fendt Expert operator training programme, you can optimise the efficiency of your Fendt even further, and get to know all the functions to make your daily routine that much easier. Our team of professional trainers will advise you on how to use your Fendt machine to its full potential.

Individual finance and lease models

Investing in technology means a considerable capital outlay. A credit finance agreement from AGCO Finance offers attractive conditions and flexible terms. From the initial down payment to monthly instalments to the payment term – you set the general terms on which to finance your Fendt. If you need additional resources in a hurry or want to use tractors over a long-term period without purchasing them, your Fendt dealer can offer the ideal solution with tailored lease packages.

Fendt Certified – Pre-owned machine programme

Leaders drive Fendt – including with pre-loved agricultural machinery. Used agricultural machinery to tried and tested high-quality standards and certified Fendt quality – the ideal solution for cost-conscious farmers or as an addition to a growing fleet.

The benefits:

- Certification according to strict quality standards
- Extensive incoming check (technology, wear, appearance)
- Fully serviced wear parts
- If required, replace, clean and paint components
- One-year warranty (option to extend)

Fendt Care – servicing and guarantee extensions

In order to keep your machine ready for action at any time, we offer a tailored maintenance and repair service beyond the statutory warranty, which only covers the repair risk of a new machine in the first 12 months after delivery. That's where Fendt Care comes in. With flexible durations and flexible rates with and without excess, the machine can be guaranteed even after the first year.

Your Fendt dealer will only install Fendt original parts. These have a proven standard of quality and are safety-tested. This ensures the best value retention for your Fendt machine.

Using the smartphone app "AGCO Parts Books to go", you can find Fendt spare parts quickly and easily and order them directly. The app is available for download in the app store and in the Google Play Store. Your personal access data is available from your Fendt dealer.

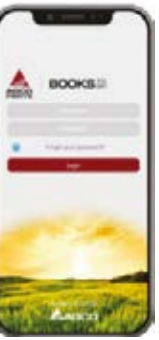

Full control over costs and planning reliability

Fendt Care	Bronze	Silver			Gold ¹	Platinum ¹
Service	Regular maintenance, fixed maintenance costs	Cover against repair risk (except wear)			All costs covered (except wear and tear)	Costs and availability covered (except wear and tear)
Benefit	Reliability of use	Coverage against major damage	Full coverage under great conditions	Full protection while you keep costs under control	Protect against all unexpected repair risks including all secondary costs	For customers who cannot afford any downtime
Regular maintenance	✓	✓	✓	✓	✓	✓
Repair costs		✓	✓	✓	✓	✓
Excess		€490	€190	€0	€0	€0
Travel costs, recovery/towing, troubleshooting with added diagnostics tools, performance testing, oils and filters, if engine/gearbox is repaired					✓	✓
After hours and weekend surcharge						✓
Replacement machine						✓

¹ Valid for UK, Germany and France. Platinum only available at participating dealers.



8 years / 8,000 operating hours

With our new Fendt Care rates, Fendt offers extensive coverage for the reliability and repair risk of new machines. Fendt Care gives you complete cost control with exceptional service. From a service agreement to the full carefree package including replacement machine, Fendt has a flexible and tailored solution for your fleet.

Quick and simple servicing.



Checking the oil level and other maintenance work is quick and easy on the Fendt 900 Vario.



The level of dirt on the air filters is shown on the Variotermin. The engine compartment is very accessible, with removable side panels.



The cab filter is easily accessible in the entrance area and can be easily cleaned when needed.



Clean the cab quickly thanks to the practical pressure hose connection.

Fendt extras.



Fendt extras are a great addition to your Fendt machine. Choose from an extensive range of products including lubricants, AdBlue, care kits, cab accessories and much more. All extras are available for purchase exclusively from your Fendt dealer.



What can we do for you?

What makes Fendt Services different?

For us, service means knowing and understanding your work in order to meet your demands for reliability and safety and to act in your economic interest. We stand behind our products and have developed them for the highest demands and long-term operation. Our service is the partnership aspect for your work.

How do I get a software update?

Fendt software is update-compatible, so your Fendt always features the latest technology. This safeguards the technological progress and value retention of your Fendt machine and keeps your investment as fresh as it was on day one. Contact your Fendt dealer for details.

What is Fendt Expert?

Become an expert on the Vario Profi with Fendt Expert driver training: Are you already familiar with all the functions that the technology has to offer? Take advantage of the technology in every Fendt Vario and learn how to make best use of every feature, with Fendt Expert. Our team of professional trainers will advise you on how to use the full potential of your Fendt tractor. Contact your dealer for details and register today.

fendt.com

Find everything on line – from brochures to technical specifications, from reports about customers or our company to our Fendt event calendar.

Fendt Configurator

With the Fendt Vehicle Configurator, you can choose from all the available equipment variations and put together the optimally equipped vehicle for your farm. The Fendt Configurator is available online at www.fendt.com, where you will find a quick link to it directly on the start page.

fendt.tv

Fendt around the clock – our Fendt Media Library makes it possible. Our Internet TV provides you with news and information about Fendt 24/7.

Test drives

Go to fendt.com and select "Fendt Services" on the "Service" page, select the "Demo Service", then register for a test drive with the tractor of your choice.



FENDT

It's Fendt. Because we understand Agriculture.



www.fendt.com

AGCO GmbH – Fendt Marketing
87616 Marktberdorf, Germany

 **AGCO**
Your Agriculture Company

Fendt is a worldwide brand of AGCO.
All details regarding scope of delivery, appearance, performance, dimensions and weights, fuel consumption and running costs of vehicles reflect the latest information available at the time of print. These may change by the time of purchase. Your Fendt dealer will be happy to inform you about any changes. The vehicles shown do not feature country-specific equipment.